

ELECTRICAL

Fuses

ONE-TIME General Purpose — NON And NOS Power Distribution Fuses — 600 Volts (or less)

CATALOG SYMBOL NON (250V), NOS (600V)
FOR GENERAL PURPOSE APPLICATION ¼ TO 600 AMPERES

250 AND 600 VOLTS AC (OR LESS)

NON-CURRENT LIMITING

INTERRUPTING RATING — 50,000 RMS SYM.

(1-60A); 10,000A (70-600A)

UL LISTED — Class K5 (1-60A); H (70-600A)

Application and Sizing

These fuses are usually applied to protect lighting, heating and other circuits not subject to temporary surges and where available short-circuit currents are relatively low. ONE-TIME fuses do not have any appreciable degree of time-delay and thus should not be specified in circuits where large transients or motor overloads occur. Use Bus Fusetron or Low-Peak dual-element time-delay fuses. For general purpose circuits, size at ampere rating of circuit. For motor circuits, size at 300% to 400%.

SUPER-LAG, Renewable — REN And RES (Links LKN & LKS)

CATALOG SYMBOL REN (250V), RES (600V)

TIME-LAG

1 TO 600 AMPERES

250 AND 600 VOLTS AC (OR LESS)

NON-CURRENT LIMITING

INTERRUPTING RATING — 10,000A RMS SYM.

UL LISTED — Class H

Bus SUPER-LAG Renewable fuses with longer time-delay than other CLASS H fuses of this type can better sustain over-loads without needlessly opening. The "laminated" fusible links of 70 amp and larger fuses significantly contribute to this time-delay. They are designed so that they can easily be replaced.

Application and Sizing

SUPER-LAG fuses are used in circuits of industrial and commercial structures in which maximum short-circuit currents are of a low level (below 10,000 amperes) and frequent outages dictate the economy of the "renewable" type fuse. These fuses are generally sized at the ampere rating of non-inductive circuits and 300% for motor circuits.

FUSETRON® Dual-Element Time-Delay — FRN-R And FRS-R

CATALOG SYMBOL FRN-R (250V), FRS-R (600V)

DUAL-ELEMENT TIME-DELAY — 10 SECONDS

¼ TO 600 AMPERES

250 AND 600 VOLTS AC (OR LESS)

CURRENT LIMITING

INTERRUPTING RATING — 200,000 RMS SYM

UL LISTED — Class RK5

CSA HRC-1

Unlike single-element fuses, the dual-element fuse can be applied in circuits subject to temporary motor overloads and surge currents to provide both high performance short-circuit and overload protection. Oversizing in order to prevent nuisance openings is not necessary. The dual-element fuse contains two distinctly separate types of elements. Electrically, the two elements are series connected. The fuse links similar to those used in the single-element fuse perform the short-circuit protection function, the overload element provides protection against low-level overcurrents or overloads and will hold an overload which is five times greater than the ampere rating of the fuse for a minimum time of ten seconds.

NON ONE-TIME Fuses (250 Volts AC)			NOS ONE-TIME Fuses (600 Volts AC)		
Ampere Rating	Ctn. Qty.	Wt. Lbs.	Ampere Rating	Ctn. Qty.	Wt. Lbs.
½, ¾, 1, 1½, 2, 2½, 3, 4, 5, 6, 7, 8, 10, 12, 15, 20, 25, 30	10	.38	1, 2, 3, 4, 5, 6, 7, 8, 10, 12, 15, 20, 25, 30	10	1.45
35, 40, 45, 50, 60	10	1.00	35, 40, 45, 50, 60	10	2.60
70, 80, 90, 100	5	.79	70, 80, 90, 100	5	2.80
110, 125, 150, 175, 200	1	.79	110, 125, 150, 175, 200	1	1.24
225, 250, 300, 350, 400	1	1.65	225, 250, 300, 350, 400	1	3.03
450, 500, 600	1	2.76	450, 500, 600	1	4.63

SUPER-LAG Renewable Fuses					
(250 Volts AC)			(600 Volts AC)		
Ampere Rating	Ctn. Qty.	Wt. Lbs.	Ampere Rating	Ctn. Qty.	Wt. Lbs.
1, 2, 3, 4, 5, 6, 8, 10, 12, 15, 20, 25, 30	10	.55	1, 2, 3, 4, 5, 6, 8, 10, 12, 15, 20, 25, 30	10	.18
35, 40, 45, 50, 60	10	1.40	35, 40, 45, 50, 60	10	.36
70, 80, 90, 100	5	2.30	70, 80, 90, 100	5	4.16
110, 125, 150, 175, 200	1	1.09	110, 125, 150, 175, 200	1	1.83
225, 250, 300, 350, 400	1	2.66	225, 250, 300, 350, 400	1	3.73
450, 500, 600	1	3.13	450, 500, 600	1	3.75

FRN-R FUSETRON Fuses (250 Volts AC)			FRS-R FUSETRON Fuses (600 Volts AC)		
Ampere Rating	Ctn. Qty.	Wt. Lbs.	Ampere Rating	Ctn. Qty.	Wt. Lbs.
½, ¾, 1, 1½, 2, 2½, 3, 4, 5, 6, 7, 8, 10, 12, 15, 17½, 20, 25, 30	10	.40	½, ¾, 1, 1½, 2, 2½, 3, 4, 5, 6, 7, 8, 10, 12, 15, 17½, 20, 25, 30	10	1.50
35, 40, 45, 50, 60	10	1.00	35, 40, 45, 50, 60	10	2.81
70, 75, 80, 90, 100	5	1.50	70, 75, 80, 90, 100	1	.54
110, 125, 150, 175, 200	1	.77	110, 125, 150, 175, 200	1	1.20
225, 250, 300, 350, 400	1	1.52	225, 250, 300, 350, 400	1	3.00
450, 500, 600	1	2.94	450, 500, 600	1	5.00

PHONE (785) 827-4491
FAX (785) 827-4494

GRAIN BELT SUPPLY CO., INC.

SALINA, KANSAS

U.S. 1-800-255-2742
1-800-432-8292
1-800-447-0522



ELECTRICAL

Lighting Equipment

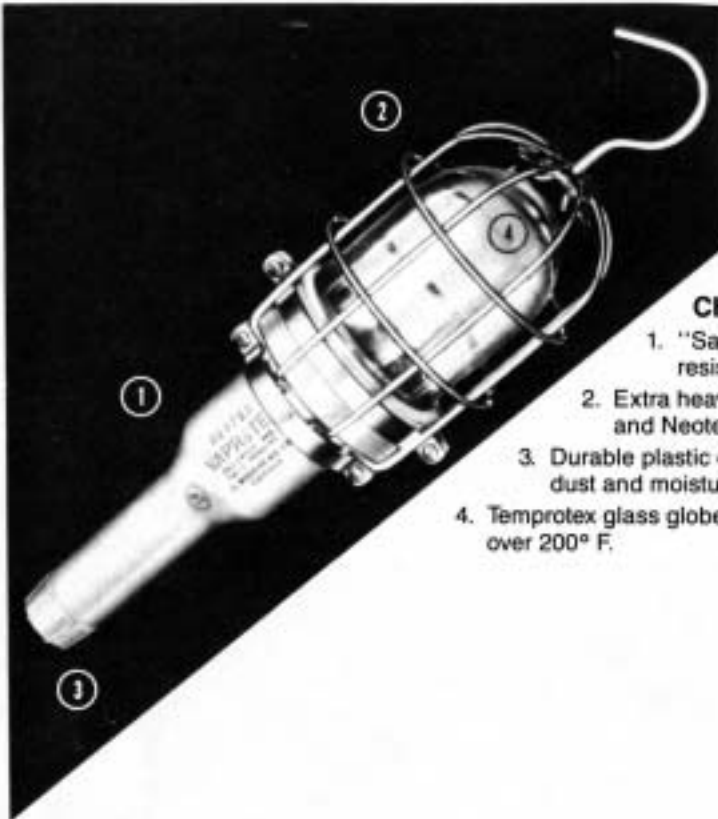

Vaprotex Vaporproof Portable Hand Lamp (NOT EXPLOSION PROOF)

Vaprotex Vaporproof construction gives you maximum safety. Temprotex globe screws into handle, eliminates gaskets, and gives vapor-proof seal.

CHECK THESE VAPROTEX FEATURES:

1. "Safety Yellow" Neotex handle. New compound is oil-proof, resists even hydraulic fluids.
2. Extra heavy steel wire guard seals lighting chamber. Cast aluminum and Neotex insulated cover guards also available.
3. Durable plastic compression grip seals cord entry in handle against gases, dust and moisture.
4. Temprotex glass globe — impact resistant and withstands thermal variations of over 200° F.

Incandescent Hand Lamps (EXPLOSION PROOF)



Hazardous (Classified) Location Hand Lamp

U.L. Listed

Specifications

Construction: Raintight, weather-resistant and spark-resistant construction. Nylon handle and cord clamp, with internal strain relief to avoid exposed screws. Tempered glass globe screws into handle. Non-sparking aluminum guard and full-swivel hook; hook cannot pull out of assembly. Supplied with rubber grommets to accommodate 16/3 or 14/3 cord.



Mill Type Lamp Bulb

This sturdily constructed bulb will last many more hours than the ordinary bulb. The filament is extra strong to withstand constant vibration and use. Inside frosted.

PHONE (785) 827-4491
FAX (785) 827-4494

GRAIN BELT SUPPLY CO., INC.

SALINA, KANSAS

U.S. 1-800-255-2742
1-800-432-8292
1-800-447-0522



ELECTRICAL

Ventilators & Fans

EMPIRE 4" TO 24" ROTARY ROOF VENTILATORS Exhausts Air Automatically. Slight Breeze Rotates Turbine. Outside Braced.



Dependable, low cost, rotary roof ventilator exhausts air automatically, continuously and silently—no operating or maintenance cost. Slightest breeze over roof causes turbine to rotate and create a vacuum within turbine that is replaced by a strong upward draft of air, achieving a hot or cold exhaust. Ideal for sluggish chimneys and flues. Outside braced for strength, safety and perfect alignment. Precision built with lifetime bearings. Galvanized steel, aluminum painted.

Neck Dia.	CFM 4 MI. Wind	Stock No.	Shpg. Wt.
4"	126	4C016	7
6"	147	2C528	9
8"	255	2C529	10
10"	425	2C530	13
12"	631	2C531	16
14"	700	2C532	26
16"	950	2C533	33
18"	1200	2C534	40
20"	1700	2C802	45
24"	2350	2C803	70

24" to 60" INDUSTRIAL/ COMMERCIAL FANS

Use in attic for house cooling or for high-volume exhausting in commercial buildings. These fans, belt driven for quietness, will give efficient trouble-free service. CFM measured at 0 inches static pressure. Heavy steel panel with efficient venturi discharge. Supports are welded for maximum rigidity. Self-aligning bronze bearings. Cast iron blade sheave. Fans come with drive hardware, and motor.

Blade Dia.	H.P.	R.P.M.	C.F.M.
24"	1/2	845	6,900
30"	3/4	640	10,200
36"	1	545	13,650
42"	1 1/2	495	19,300
48"	2	455	25,100
54"	3	440	33,100
60"	5	450	45,200

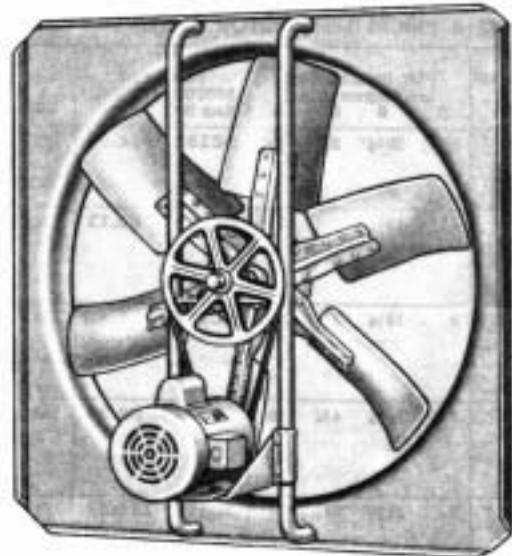

TIE-ROD FAN SHUTTERS

Quality line of automatic tie-rod shutters. Responsive, quiet, weather-tight, dependable. Tie-rod assures a uniform action to 90° opening. Aluminum vanes with felted edges and bronze bearings.

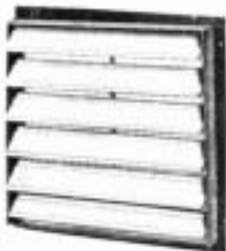

SINGLE PANEL SHUTTERS FOR 10" to 30" DIA. FANS

Fan Diameter	Opening Require Square	Overall Dimension Square	Shipping Weight
10"	11"	13 1/4"	5
12	13	15 1/4"	6
16	17	19 1/4"	8 1/2
18	19	21 1/4"	10
20	21	23 1/4"	12
24	25	27 1/4"	13
30	31	33 1/4"	19
36	37	39 1/4"	26

DOUBLE PANEL SHUTTERS FOR 10" to 30" DIA. FANS (*)

Fan Diameter	Opening Require Square	Overall Dimension Square	Shipping Weight
36"	37"	39 1/4"	28
42	43	45 1/4"	35
48	49	51 1/4"	42
54	55	57 1/4"	60
60	61	63 1/4"	76

PHONE (785) 827-4491
FAX (785) 827-4494

GRAIN BELT SUPPLY CO., INC.
SALINA, KANSAS

U.S. 1-800-255-2742
1-800-432-8292
1-800-447-0522



ELECTRICAL

Bin Vibrators

**Unstick Stuck Bins . . .
Eliminate Troublesome Slow-
downs Caused by Sticking,
Arching, Stubborn Materials**

**CHOOSE FROM A WIDE SELECTION . . .
NO RECTIFIERS REQUIRED . . . NOISELESS,
SEMI-NOISELESS AND IMPACT MODELS . . .
ALL WITH CONCENTRATED "PINPOINT"
VIBRATION FOR PEAK PERFORMANCE**

Choose from 12 models . . . for applications ranging from the tiniest hopper (5 cu ft (.14 cu m) capacity) to huge bunkers with reinforced heavy steel plate and liners.
You need no rectifiers . . . HI-VI units operate direct from AC power supply. Simple, compact controls are available so you can adjust vibrator performance to handle product variations.
HI-VI's concentrated vibration, with its powerful positive drive in both directions, applies a superior action to bin walls . . . and results in more economical, more efficient flow of hard-to-handle materials.



**SERIES
40P - 40S**

All models are easily and quickly installed, singly or in groups on bins, hoppers, etc. . . . all are built with weather and dust-resistant housings at no extra cost . . . have no sliding or rotating parts to wear . . . never need lubrication. HI-VI's ERIUM magnetic element is permanent; it will never weaken or wear out.
All Eriez standard vibrators are built to operate efficiently at ambient temperatures up to 130°F (55°C). Models 30P, 40P, 50P and 55P are available in special high-temperature construction to withstand temperatures up to 300°F (150°C).

RATINGS, CHARACTERISTICS AND DIMENSIONS

	23N		30N		33P-30S		40P		40S		50P		50S		55P-50S		60U		70U					
Power Supply (50 or 60 cycle, single phase)	115, 230, 460V																				115, 230 460, 575V			
Full Load Power Input & Current at 115V/60	20W/1.8A		40W/1.2A		10W/1.5A		30W/1.4A		40W/1.6A		40W/1.6A		45W/1.6A		60W/1.4A		110W/1.4A		130W/1.7A					
Control	D		F1		D		F1		F1		F1		F1		G		G		GH					
Weight Without Control Box	lb	kg	lb	kg	lb	kg	lb	kg	lb	kg	lb	kg	lb	kg	lb	kg	lb	kg	lb	kg				
Weight With Control Box	14½	8.6	23	10.4	23	10.4	47	21.3	52	23.6	56	25.4	61	27.7	84	38.1	172	78.0	322	146.1				
Shipping Weight Less Control Box	13	5.9	21	9.5	22	10.0	46	20.9	51	23.1	55	24.9	60	27.2	82	37.2	170	77.1	320	145.1				
	in.	mm.	in.	mm.	in.	mm.	in.	mm.	in.	mm.	in.	mm.	in.	mm.	in.	mm.	in.	mm.	in.	mm.				
ALL UNITS HAVE A WEATHER- AND DUST-RESISTANT ENCLOSURE	A Dia.	6¼	158.8	8½	216	8¼	225.4	11¼	285.7	11¼	285.7	11¼	285.7	11¼	285.7	11¼	285.7	18¾	476.2	23	584.2			
	B	37/16	87.3	4¼	108	5¼	142.9	5¼	146	5¼	146	5¼	146	5¼	146	8¼	235	10¾	269.9	14	355.6			
	C	7½	190.5	10	254	10	254	6½	165.1	6½	165.1	6½	165.1	6½	165.1	11½	292.1	8¼	219.1	18¼	460.3			
	D	7½	190.5	7½	190.5	7½	190.5	7½	190.5	7½	190.5	7½	190.5	7½	190.5	7½	190.5	7½	190.5	6	152.4	15½	393.7	
	E	5¼	142.9	6¼	174.6	5	127	77/16	185.7	77/16	185.7	77/16	185.7	77/16	185.7	9¾	248.6	9¾	248.6	11¼	285.3			
	F	77/16	111.1	¾	15.9	¾	15.9	¾	15.9	¾	15.9	¾	15.9	¾	15.9	77/16	111.1	¾	15.9	¾	15.9	77/16	111.1	
	G	¾	19.0	¾	19.0	¾	19.0	¾	19.0	¾	19.0	¾	19.0	¾	19.0	¾	19.0	¾	19.0	¾	19.0	77/16	111.1	
	H																					14	355.6	17½
BASE IS PAINTED BLACK --- COVER IS MACHINE TOOL GRAY																								

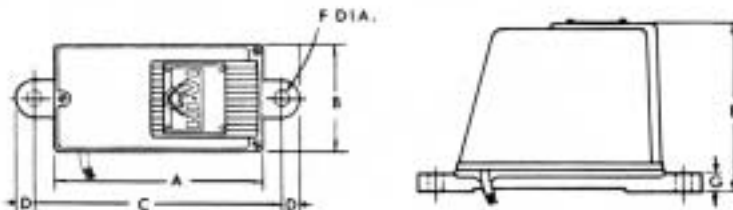

PHONE (785) 827-4491
FAX (785) 827-4494

GRAIN BELT SUPPLY CO., INC.
SALINA, KANSAS

U.S. 1-800-255-2742
1-800-432-8292
1-800-447-0522



ELECTRICAL

BV & HCV Pneumatic Piston Vibrators

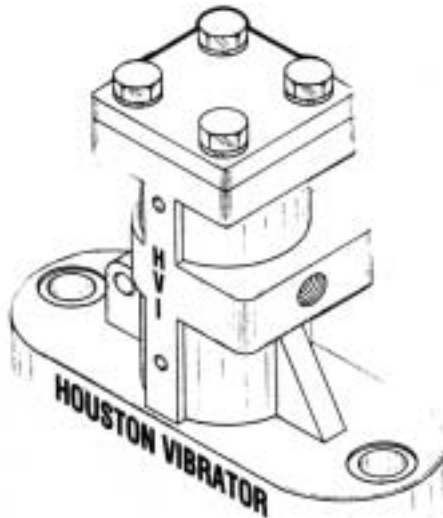

Your Problem: Stubborn Bulk Solids in Bins, Hoppers, Chutes and Railcars.

Our Solution: HVI Piston Vibrators
Powerful Linear Force Will
Dislodge Your Problems.

BIN VIBRATOR (BV) SIZE RECOMMENDATIONS

MODEL	PISTON SIZE	HOPPER CAPACITY	HOPPER THICKNESS
BV-112	1-1/8	5 CU. FT.	1/16" - 1/8"
BV-150	1-1/2	15 CU. FT.	1/16" - 1/8"
BV-175	1-3/4	30 CU. FT.	3/16" - 1/4"
BV-225	2-1/4	60 CU. FT.	3/16" - 1/4"
BV-312	3-1/8	12 TON & UP	1/4" - 3/8"
BV-350	3-1/2	20 TON & UP	1/4" - 3/8"
BV-425	4-1/4	55 TON & UP	3/8" - 1/2"
BV-650	6-1/2	300-1000 TON	3/8" - UP
BV-825	8-1/4	800-1500 TON	1/2" - UP

*RECOMMENDATIONS ARE FOR "IMPACT" TYPE VIBRATORS.
IF "AIR CUSHION" VIBRATORS ARE REQUIRED FOR LOWER NOISE LEVEL, USE ONE SIZE LARGER OR MULTIPLE UNITS.

Dimensional Data - Piston Vibrators

HVI MODEL NUMBER	ALL DIMENSIONS IN INCHES								WT
	A	B	C	D	Wiring & Cables	F	G	HPT Inlet	
BV-112	3 1/4"	4 1/2"	2"	1 1/2"	3 1/2"	1"	1 1/4"	1/2"	4
BV-150	5 1/2"	6"	2 1/2"	1 1/2"	4 1/2"	1 1/4"	1 1/2"	1/2"	9
BV-175	BV-225	7 1/4"	9"	3 1/2"	1"	7 1/2"	1 1/4"	1 1/2"	21
BV-312	BV-350	9 1/4"	8 1/2"	5"	1 1/2"	7 1/4"	3 1/4"	1 1/2"	53
BV-425		12"	14"	6"	1 1/2"	12"	4"	1"	98
BV-650		38"	14"	18"	2"	11"	7"	1 1/2"	389
HCV-312	HCV-350	14 1/4"	8"	8"	8"	5 1/4"	6 1/2"	1 1/2"	75

Bulk Material Flow Control

- **Low Initial Cost**
- **Piston Actions** - All Models Available in either Impact or Air-Cushion
- **Tef-Kote** - Lubricated Units Available
- **Virtually Maintenance Free** - When Used with Filtered, Lubricated Air Supply
- **Heavy Ductile Iron Casting** and Ground Chrome Plated Piston
- **Complete Control** - Over Force, Amplitude and Frequency with Use of Pressure Regulator

Models - BV-112, BV-150, BV-175 and BV-225

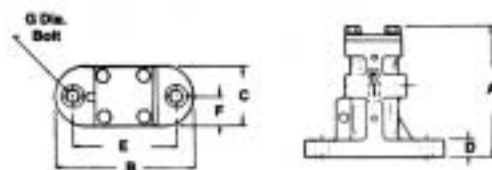

Models - BV-312, BV-350 and BV-425

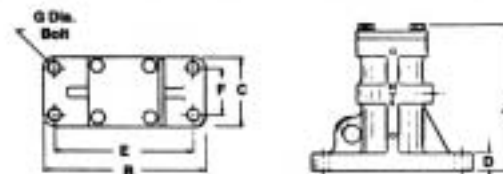

Models - HCV-312 and HCV-350

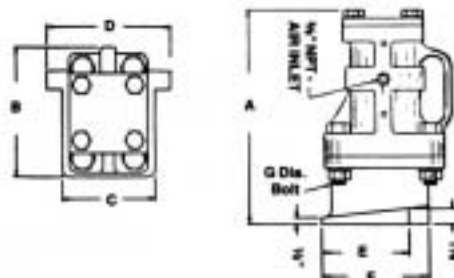

PHONE (785) 827-4491
FAX (785) 827-4494

GRAIN BELT SUPPLY CO., INC.

SALINA, KANSAS

U.S. 1-800-255-2742
1-800-432-8292
1-800-447-0522



ELECTRICAL

Bin Level Indicators

GRII SERIES FAIL-SAFE ROTARY LEVEL INDICATORS

- Eliminate material spills due to mechanical or power failure
- Visual status of level conditions
- Monitors paddle rotation, paddle covered and fault conditions
- Supervisory circuitry providing remote monitoring of normal and fault conditions
- Genuine Fail-Safe integrity offered only by Bin-Master
- Units designed to meet NEMA 4X, 5, 7, 9 & 12
- Capable of multiple power supply



PRO I & PRO II CAPACITANCE PROBE

- No moving parts
- Ignores material build up
- "Quick Set" calibration
- Visual status of probe condition
- Genuine Fail-Safe integrity
- Units to meet NEMA 4X, 5, 7, 9, 12
- Multiple power supply capability
- Optional Probes available



TILT SWITCH

- High level or limit switch applications
- One moving part, minimal maintenance
- Simple, reliable & affordable



ROTARY LEVEL INDICATOR

- Proven reliability with prolonged motor life
- Minimal motor burnout due to unique slip clutch & De-Energizing status
- Interchangeable with other rotary units
- U/L, CSA listed for hazardous locations



PRESSURE SENSITIVE DIAPHRAGM

- Inexpensive high & low level indicator
- Minimal long-term maintenance expense
- Internal or external installation for easy accessibility
- U/L listed for hazardous locations



BIN BOB REMOTE

- Wall mount enclosure with LED readout
- Capable to monitor 12 bins
- Measures "feet of" or "feet to" product
- Direct PLC operation capabilities



BIN-MASTER CONTROL PANEL

- Control Panels with 4, 8, 12, 18 & 24 stations
- Illuminating light for individual level indicators
- Built-in alarm buzzer with manual override toggle switch
- Rugged metal housing
- Centralize several level indicators into one location



PHONE (785) 827-4491
FAX (785) 827-4494

GRAIN BELT SUPPLY CO., INC.

SALINA, KANSAS

U.S. 1-800-255-2742
1-800-432-8292
1-800-447-0522

